

**SCHEDULE OF RECOMMENDED FOUNDATION PIER MIN. SIZES**

		5"x5" POST, 8'-0" MAX. COLUMN HEIGHT												
		Bedrock			Gravel			Sand			Clay			Unknown Fill / Organics
		Friction Angle, f = 40o (min)			Friction Angle, f = 35o (min)			Friction Angle, f = 30o (min)			Friction Angle, f = 0o (min)			
		Cohesion, c = 10,000 psf (min)			Cohesion, c = 0 psf (min)			Cohesion, c = 0 psf (min)			Cohesion, c = 1000 psf (min)			
		Bearing = 3000 psf			Bearing = 2000 psf			Bearing = 2000 psf			Bearing = 1500 psf			
		Total Density gt = 130 pcf (min)			Total Density gt = 120 pcf (min)			Total Density gt = 115 pcf (min)			Total Density gt = 110 pcf (min)			Poorly-Characterized
Exposure	Wind Speed (mph)	Pier Diameter (in)		Pier Depth (ft)		Pier Steel		Pier Diameter (in)		Pier Depth (ft)		Pier Steel		
		18	3.0	4-#5	18	3.0	4-#5	18	3.0	4-#5	18	3.0	4-#5	
B	115	18	3.0	4-#5	18	3.0	4-#5	18	3.5	4-#5	24	3.5	4-#5	
	125	18	3.0	4-#5	18	3.5	4-#5	18	3.5	4-#5	24	4.0	4-#5	
	140	18	3.0	4-#5	18	4.0	4-#5	18	4.0	4-#5	24	4.0	4-#5	
	150	18	3.5	4-#5	18	4.0	4-#5	18	4.5	4-#5	24	4.5	4-#5	
	165	CONTACT ENGINEER												
C	95	18	3.0	4-#5	18	3.5	4-#5	18	3.5	4-#5	24	3.5	4-#5	
	115	18	3.5	4-#5	18	4.0	4-#5	18	4.0	4-#5	24	4.5	4-#5	
	125	18	3.5	4-#5	18	4.5	4-#5	18	4.5	4-#5	24	4.5	4-#5	
	140	CONTACT ENGINEER												
	150	CONTACT ENGINEER												
165	CONTACT ENGINEER													

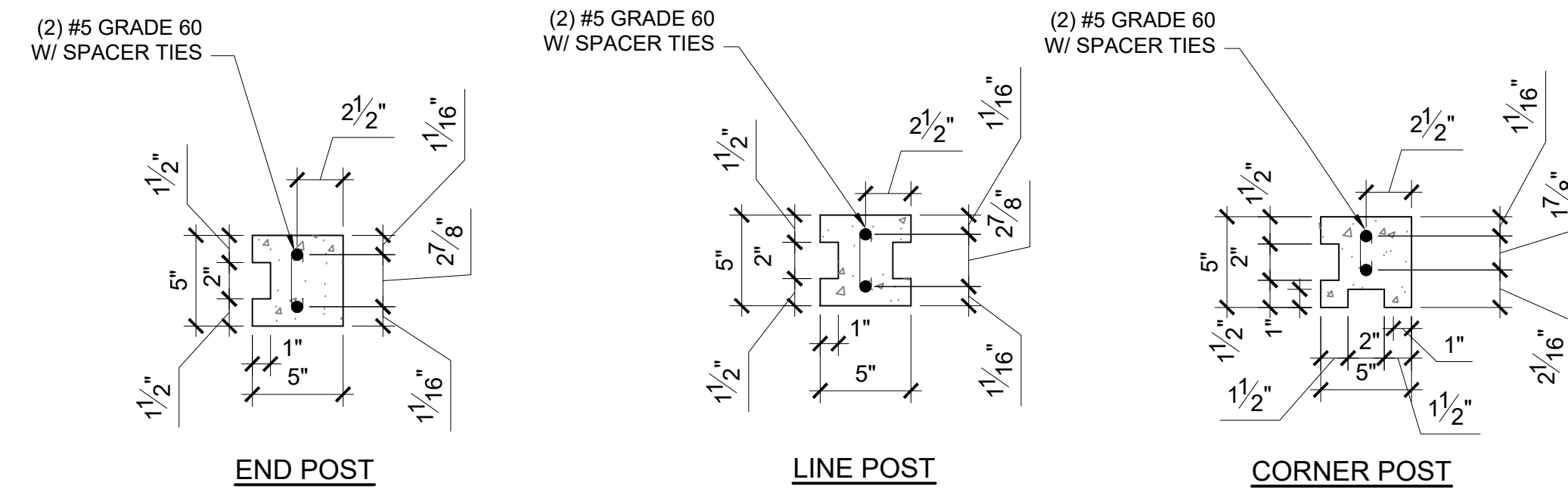

POST REINFORCEMENT FOR WIND SPEED UP TO 95 MPH

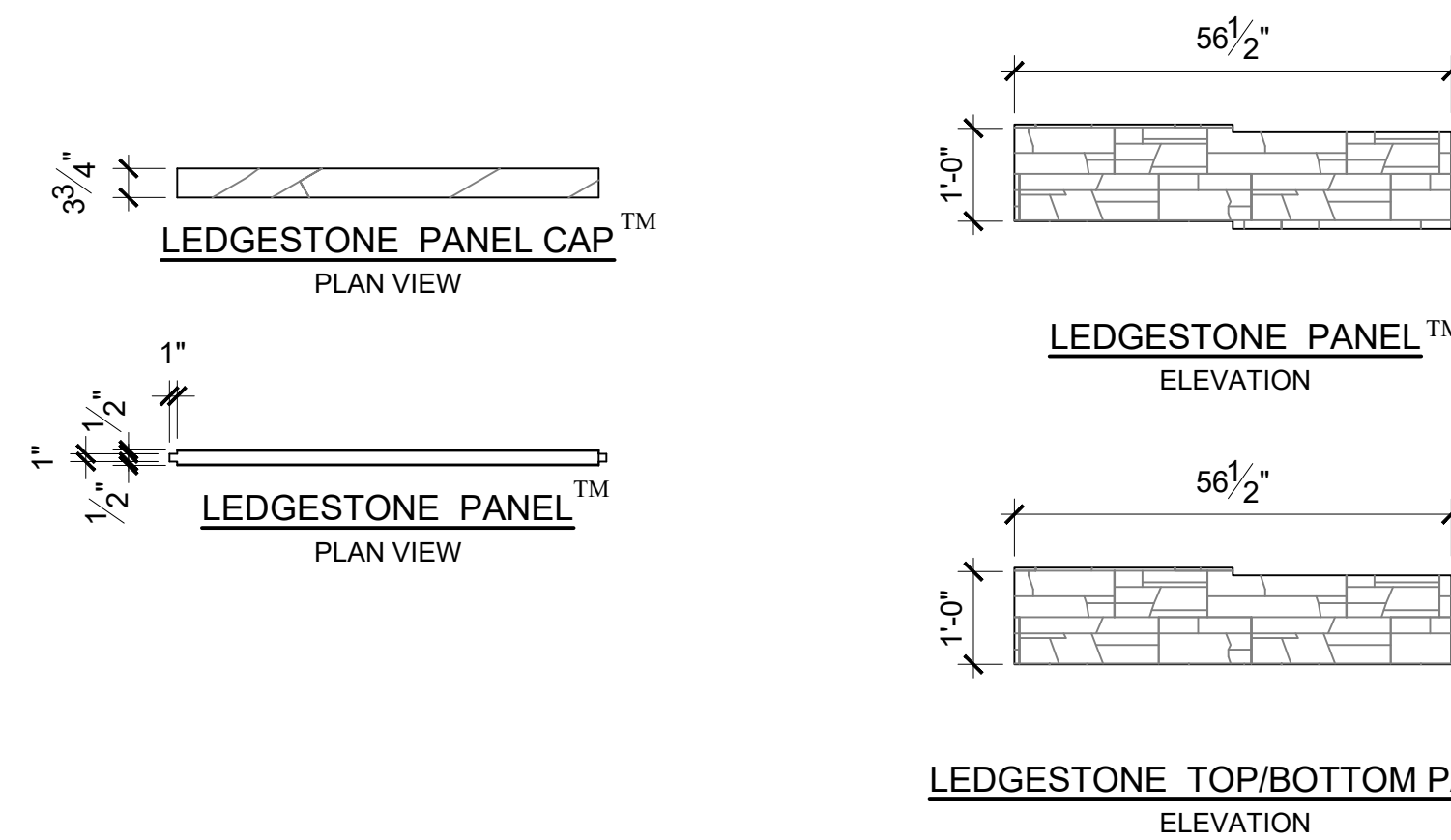
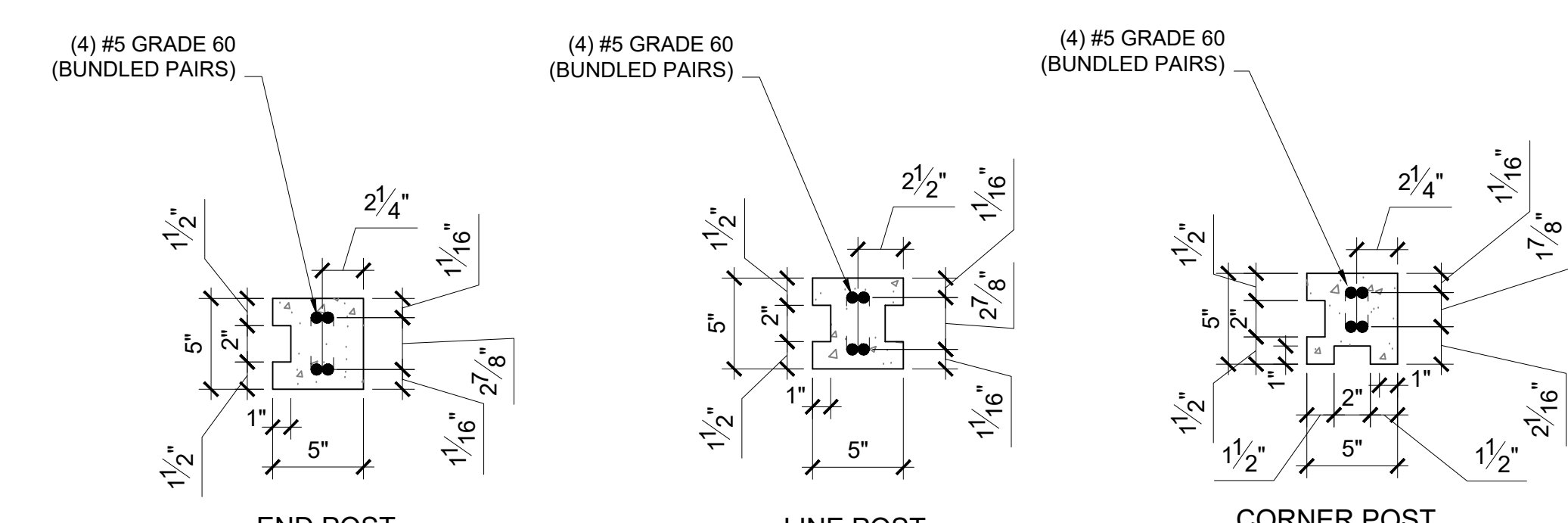

POST REINFORCEMENT FOR WIND SPEED GREATER THAN 95 MPH UP TO 165 MPH

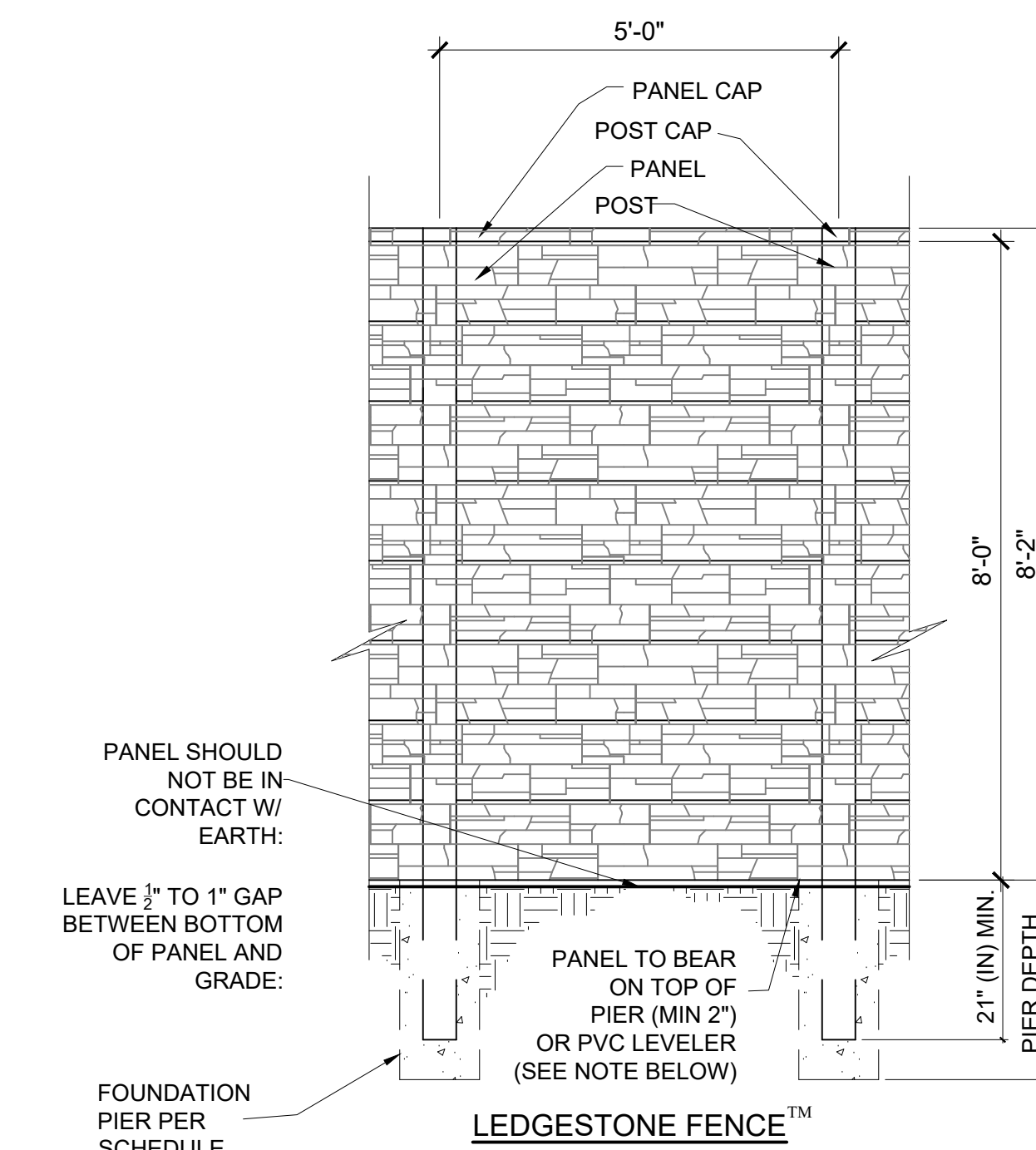
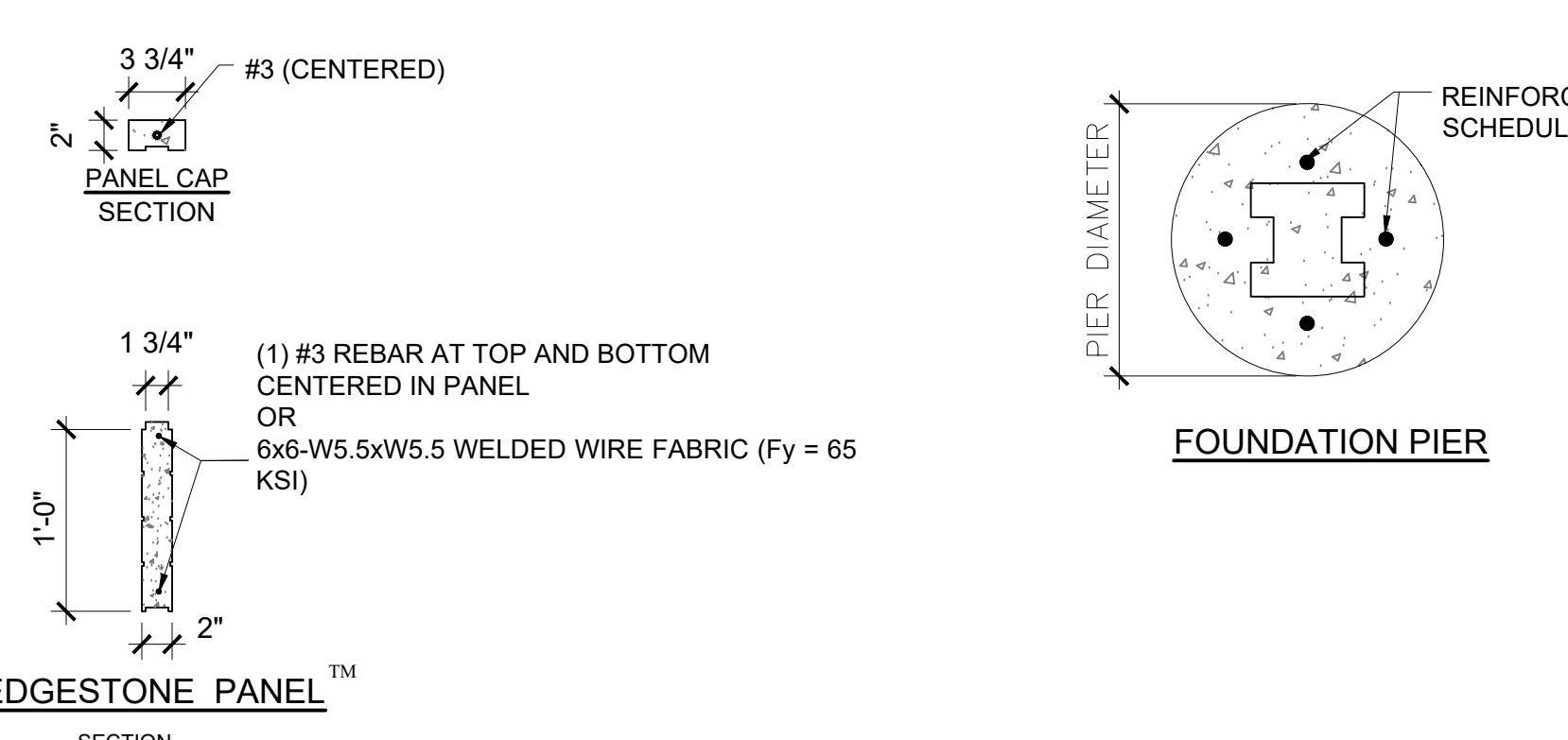

NOTE: SMALL DIAMETER PVC PIPE IS COMMONLY CAST IN PIERS TO LEVEL PANELS. IT IS ACCEPTABLE TO BEAR THE CONCRETE PANELS ON THE PVC LEVELERS. PVC LEVELERS MUST BE SCHEDULE 40 W/ A MINIMUM NOMINAL DIAMETER OF 1". THE PVC LEVELERS MAY EXTEND 1/2" MAX ABOVE THE TOP OF THE CONCRETE PIER.

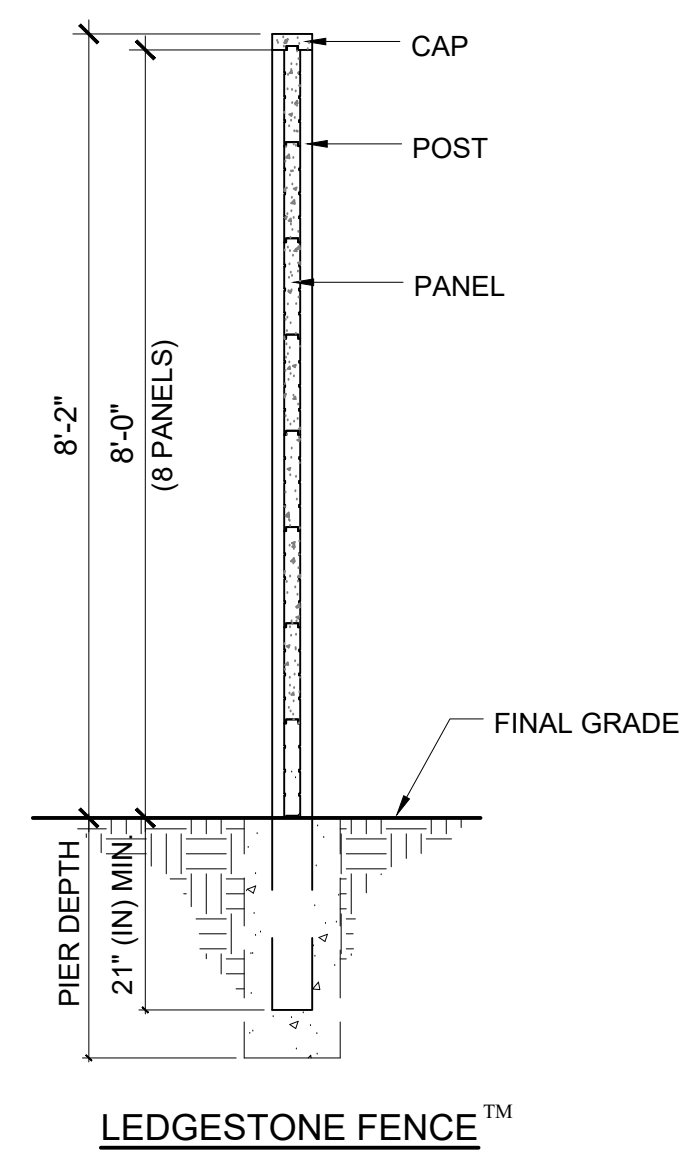

LEDGESTONE FENCE SECTION

**SPECIFICATION DATA**

- PRODUCT NAMES: LEDGESTONE COLUMN UNFINISHED COLUMN
- MANUFACTURER: SIGNATURE STONE, LLC. 211 30TH STREET GREELEY, CO 80631
- PRODUCTS DESCRIPTION: PRODUCTS ARE INTENDED FOR RESIDENTIAL, COMMERCIAL, AND INDUSTRIAL EXTERIOR FENCING, SCREENING WALLS AND NOISE BARRIERS.
- COMPOSITION AND MATERIALS: A MIX OF HIGH STRENGTH PORTLAND CEMENT CONCRETE W/ FIBER MESH REINFORCING, MEETING OR EXCEEDING THE REQUIREMENTS OF ASTM-C150, NATURAL AGGREGATES, AND IRON OXIDE COLORS PLACED AND CAST WITHIN FACTORY MOLDS. FILLED MOLDS ARE VIBRATED AFTER SETUP OF MIX, CURED, AND PACKAGED FOR SHIPMENT.
- SIZES: FENCE POSTS ARE TYPICALLY PLACED AT 60.0 in. CENTERS WITH THE FENCE PANELS BEING 12.0 in. IN HEIGHT AND APPROXIMATELY 2.0 in. IN THICKNESS. HEIGHT OF THE FENCE SYSTEM SHOULD NOT EXCEED THAT SHOWN. CONTACT MANUFACTURER FOR ENGINEERING NOT INCLUDED IN THESE SPECIFICATIONS.
- LIMITATIONS: FENCE SYSTEM IS DESIGNED FOR TYPICAL CONDITIONS AND APPLICATIONS. SIGNATURE STONE RECOMMENDS FENCE SYSTEM APPLICATION AND FOUNDATION INSTALLATION BE APPROVED BY LOCAL PROFESSIONAL ENGINEER ON EVERY PROJECT. FENCE SYSTEM SHOULD NOT BE USED AS AN EARTH RETENTION SYSTEM UNLESS MODIFICATIONS IN DESIGN AND CONSTRUCTION ARE DONE BY A REGISTERED PROFESSIONAL ENGINEER AND APPROVED BY THE MANUFACTURER.
- TECHNICAL DATA FOR CONCRETE MIX: PRE-CAST FENCE POSTS AND PANELS: MIN. 28 DAY COMPRESSIVE STRENGTH = 5,000 psi. CAST-IN-PLACE FOUNDATION PIERS: MIN. 28 DAY COMPRESSIVE STRENGTH = 3,000 psi.
- BUILDING CODES: DESIGN OF FENCE POSTS, PANELS AND FOUNDATION PIERS IS BASED ON 2015 VERSION OF IBC, ACI, AND AASHTO CODES.
- INSTALLATION: THE POSTS ARE POSITIONED AND WET-SET INTO A DRILLED CONCRETE FOUNDATION PIER. THE PIER SIZE, DEPTH AND REINFORCEMENT SHALL BE AS SPECIFIED BY LOCAL ENGINEER OR AS SHOWN ON SCHEDULE. AFTER POSTS ARE ACCURATELY SPACED, PLUMBED AND LEVELED, THEY ARE BRACED UNTIL PIER CONCRETE HAS OBTAINED ITS INITIAL STRENGTH. THE PANELS ARE MANUALLY SLID INTO PLACE BETWEEN THE ACCURATELY POSITIONED POSTS. IF NECESSARY, PANEL LENGTHS CAN BE MODIFIED SLIGHTLY BY SAW CUTTING. POST CAPS AND PANEL CAPS ARE BONDED INTO PLACE BY APPLYING SIKAFLEX-1A ADHESIVE BETWEEN THE CAP AND FENCE COMPONENT.
- DRAINAGE: THE LONG-TERM PERFORMANCE OF ALL FOUNDATIONS, INCLUDING THE SIGNATURE STONE FENCE FOUNDATION, DEPENDS ON PROPER GRADING. POSITIVE DRAINAGE AWAY FROM THE FENCE FOUNDATIONS TO THE EXTENT POSSIBLE IS RECOMMENDED AT ALL TIMES. PANELS CAN BE ARRANGED TO ALLOW FOR CONTINUOUS OR INTERMITTENT DRAINAGE BENEATH THE FENCE WHERE NECESSARY, IF REQUIRED BY PERMITTING AUTHORITY.

**GENERAL NOTES:**

- ALL CONSTRUCTION TO MEET LOCAL CODES AND AMENDMENTS
- ALL CONCRETE FOOTINGS SHALL USE TYPE III CEMENT.
- ALL REINFORCING STEEL SHALL CONFORM TO ASTM A 615, GRADE 60 (GRADE 40 FOR #3 REBAR ONLY).
- ALL PIER FOUNDATIONS ARE TO BE LOCATED IN UNDISTURBED SOIL, UNLESS APPROVED BY A GEOTECHNICAL ENGINEER.
- FENCE WALL PANEL STANDARD DESIGN IS FOR A WIND LOAD OF 165 MPH (ULTIMATE). WIND PRESSURE IS BASED ON ASCE 7-10, WHICH MEETS OR EXCEEDS IBC WIND PRESSURES.
- APPROVAL OF THE ENGINEER IS REQUIRED WHEN FENCE IS USED UNDER A CONDITION WHERE THE SPECIFICATIONS ARE DIFFERENT THAN SHOWN.
- THE CONTRACTOR SHALL VERIFY ALL CONDITIONS AT THE JOB SITE.
- SIGNATURE STONE CONCRETE FENCING THAT IS INSTALLED IN A LOCATION WHERE IT COULD BE EXPOSED TO ROAD SALTS OR DEICING CHEMICALS IS RECOMMENDED TO BE SEALED PERIODICALLY WITH A SILOXANE WATER REPELLENT THAT IS SPECIFICALLY FORMULATED FOR THIS APPLICATION.
- A FULLY DIMENSIONED PLOT PLAN IS REQUIRED FOR A BUILDING PERMIT AND MUST BE PROVIDED WITH EACH STANDARD PLAN.
- LOCATION AND FENCE HEIGHT SHALL COMPLY WITH CITY/COUNTY FENCING CODES AND CURRENT CONDITIONS.
- ALL WORK SHALL COMPLY WITH CITY/COUNTY GRADING ORDINANCES.

LEDGESTONE PRIVACY FENCE SYSTEM

**CTL THOMPSON**  
INCORPORATED  
P.O. BOX 8465  
FORT COLLINS, CO 80524  
www.cctl.com

THESE DRAWINGS AND ACCOMPANYING SPECIFICATIONS SHALL BE THE PROPERTY OF SIGNATURE STONE, LLC. NO PARTS OF THESE DRAWINGS OR SPECIFICATIONS SHALL BE REPRODUCED OR TRANSMITTED IN ANY FORM OR BY ANY MEANS, ELECTRONIC OR MECHANICAL, INCLUDING PHOTOCOPYING, RECORDING, OR BY ANY INFORMATION STORAGE AND RETRIEVAL SYSTEM, WITHOUT THE WRITTEN PERMISSION OF SIGNATURE STONE, LLC.

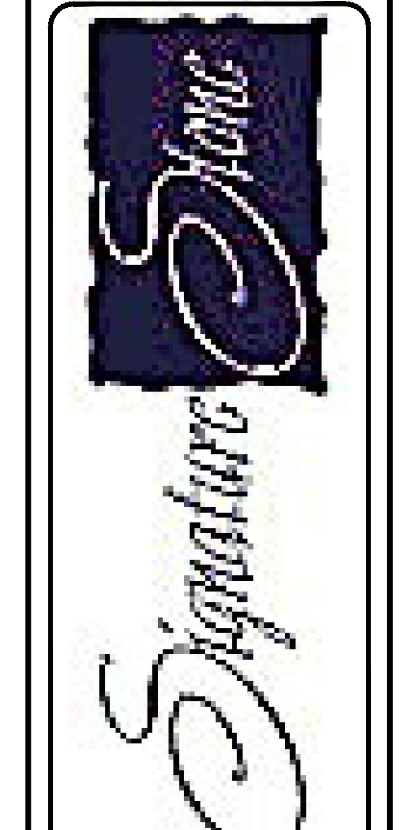

SIGNATURE STONE 8' PRIVACY FENCE SYSTEM	
REV. DATE	REVISION/ISSUE
1	1
2	2
3	3

CLIENT: SIGNATURE STONE  
211 30TH STREET  
GREELEY, COLORADO, 80631  
contact: ERIC BOEHRNER  
(970) 351-0270

TDM	S3
DES	
FC07305.000	
01/10/2020	
PER PLAN	

NOTE: ALL DIMENSIONS SHOWN ON THIS SHEET ARE FOR INFORMATION PURPOSES ONLY. ACTUAL DIMENSIONS MAY VARY DUE TO MANUFACTURING AND MOLDING TOLERANCES.